



MegaLife

# OWNER'S MANUAL

---

Split Type Floor-standing Air Conditioner

Model: T ŠĚ/H48AH-M3DNA5A

Thank you for choosing our product.

For proper operation, please read and keep this manual carefully.

If you have lost the Owner's Manual, please contact the local agent or visit

www.megalife.com

# Content

## Operation Notices

|                   |   |
|-------------------|---|
| Precautions ..... | 1 |
| Parts' Name ..... | 6 |

## Operation Guide

|   |    |
|---|----|
| Button's Name and Function .....                                    | 7  |
| Introduction for icons on display screen of air conditioner .....   | 7  |
| Button's introduction .....   | 8  |
| Buttons on remote controller .....                                  | 12 |
| Introduction for icons on display screen of remote controller ..... | 12 |
| Introduction for buttons on remote controller .....                 | 13 |
| Function introduction for combination buttons .....                 | 17 |
| Operation guide .....   | 18 |
| Replacement of batteries in remote controller .....                 | 18 |

## Maintenance

|                             |    |
|-----------------------------|----|
| Clean and maintenance ..... | 19 |
|-----------------------------|----|

## Malfunction

|                   |    |
|-------------------|----|
| Malfunction ..... | 21 |
|-------------------|----|

## Installation Notice

|   |    |
|---|----|
| Installation dimension diagram .....                            | 25 |
| Safety precautions for installing and relocating the unit ..... | 26 |
| Tools for installation .....                                    | 27 |
| Selection of installation location .....                        | 27 |
| Requirements for electric connection .....                      | 28 |

## Installation

|                                    |    |
|------------------------------------|----|
| Installation of indoor unit .....  | 29 |
| Installation of outdoor unit ..... | 33 |
| Vacuum pumping .....               | 36 |
| Leakage detection .....            | 36 |
| Check after installation .....     | 37 |
| Test operation .....               | 37 |

## Attachment

|  |    |
|--|----|
| Installation instructions of anti-collapse chain ..... | 38 |
| Configuration of connection pipe .....                 | 39 |
| Pipe expanding method .....                            | 41 |

If it needs to install, move or maintain the air conditioner, please contact dealer or local service center to conduct it at first. Air conditioner must be installed, moved or maintained by appointed unit. Otherwise, it may cause serious damage or personal injury or death.



This marking indicates that this product should not be disposed with other household wastes throughout the EU. To prevent possible harm to the environment or human health from uncontrolled waste disposal, recycle it responsibly to promote the sustainable reuse of material resources. To return your used device, please use the return and collection systems or contact the retailer where the product was purchased. They can take this product for environmental safe recycling.



### WARNING

#### **Operation and Maintenance**

- This appliance can be used by children aged from 8 years and above and persons with reduced physical, sensory or mental capabilities or lack of experience and knowledge if they have been given supervision or instruction concerning use of the appliance in a safe way and understand the hazards involved.
- Children shall not play with the appliance.
- Cleaning and user maintenance shall not be made by children without supervision.
- Do not connect air conditioner to multi-purpose socket. Otherwise, it may cause fire hazard.
- Do disconnect power supply when cleaning air conditioner. Otherwise, it may cause electric shock.
- If the supply cord is damaged, it must be replaced by the manufacturer, its service agent or similarly qualified persons in order to avoid a hazard.
- Do not wash the air conditioner with water to avoid electric shock.
- Do not spray water on indoor unit. It may cause electric shock or malfunction.
- After removing the filter, do not touch fins to avoid injury.
- Do not use fire or hair dryer to dry the filter to avoid deformation or fire hazard.

## Precautions



### WARNING

- Maintenance must be performed by qualified professionals. Otherwise, it may cause personal injury or damage.
- Do not repair air conditioner by yourself. It may cause electric shock or damage. Please contact dealer when you need to repair air conditioner.
- Do not extend fingers or objects into air inlet or air outlet. It may cause personal injury or damage.
- Do not block air outlet or air inlet. It may cause malfunction.
- Do not spill water on the remote controller, otherwise the remote controller may be broken.
- When below phenomenon occurs, please turn off air conditioner and disconnect power immediately, and then contact the dealer or qualified professionals for service.
  - Power cord is overheating or damaged.
  - There's abnormal sound during operation.
  - Circuit break trips off frequently.
  - Air conditioner gives off burning smell.
  - Indoor unit is leaking.
- If the air conditioner operates under abnormal conditions, it may cause malfunction, electric shock or fire hazard.
- When turning on or turning off the unit by emergency operation switch, please press this switch with an insulating object other than metal.
- Do not step on top panel of outdoor unit, or put heavy objects. It may cause damage or personal injury.

## Precautions



### WARNING

#### Attachment

- Installation must be performed by qualified professionals. Otherwise, it may cause personal injury or damage.
- Must follow the electric safety regulations when installing the unit.
- According to the local safety regulations, use qualified power supply circuit and circuit break.
- Do install the circuit break. If not, it may cause malfunction.
- An all-pole disconnection switch having a contact separation of at least 3mm in all poles should be connected in fixed wiring.
- Including an circuit break with suitable capacity, please note the following table. Air switch should be included magnet buckle and heating buckle function, it can protect the circuit-short and overload.
- Air Conditioner should be properly grounded. Incorrect grounding may cause electric shock.
- Don't use unqualified power cord.
- Make sure the power supply matches with the requirement of air conditioner. Unstable power supply or incorrect wiring or malfunction. Please install proper power supply cables before using the air conditioner.
- Properly connect the live wire, neutral wire and grounding wire of power socket.
- Be sure to cut off the power supply before proceeding any work related to electricity and safety.

## Precautions



### WARNING

- Do not put through the power before finishing installation.
- If the supply cord is damaged, it must be replaced by the manufacturer, its service agent or similarly qualified persons in order to avoid a hazard.
- The temperature of refrigerant circuit will be high, please keep the interconnection cable away from the copper tube.
- The appliance shall be installed in accordance with national wiring regulations.
- Installation must be performed in accordance with the requirement of NEC and CEC by authorized personnel only.
- The air conditioner is the first class electric appliance. It must be properly grounding with specialized grounding device by a professional. Please make sure it is always grounded effectively, otherwise it may cause electric shock.
- The yellow-green wire in air conditioner is grounding wire, which can't be used for other purposes.
- The grounding resistance should comply with national electric safety regulations.
- The appliance must be positioned so that the plug is accessible.
- All wires of indoor unit and outdoor unit should be connected by a professional.
- If the length of power connection wire is insufficient, please contact the supplier for a new one. Avoid extending the wire by yourself.

## Precautions



### WARNING

- For the air conditioner with plug, the plug should be reachable after finishing installation.
- For the air conditioner without plug, an circuit break must be installed in the line.
- If you need to relocate the air conditioner to another place, only the qualified person can perform the work. Otherwise, it may cause personal injury or damage.
- Select a location which is out of reach for children and far away from animals or plants. If it is unavoidable, please add the fence for safety purpose.
- The indoor unit should be installed close to the wall.
- Instructions for installation and use of this product are provided by the manufacturer.

### Working temperature range

|                 | Indoor side DB/WB(°C ) | Outdoor side DB/WB(°C ) |
|-----------------|------------------------|-------------------------|
| Maximum cooling | 32/23                  | 43/26                   |
| Maximum heating | 27/-                   | 24/18                   |

### **NOTICE:**

- The operating temperature range (outdoor temperature) for cooling only unit is 18°C ~ 43°C ; for heat pump unit is -15°C ~ 43°C.

# Parts' Name

## Indoor Unit

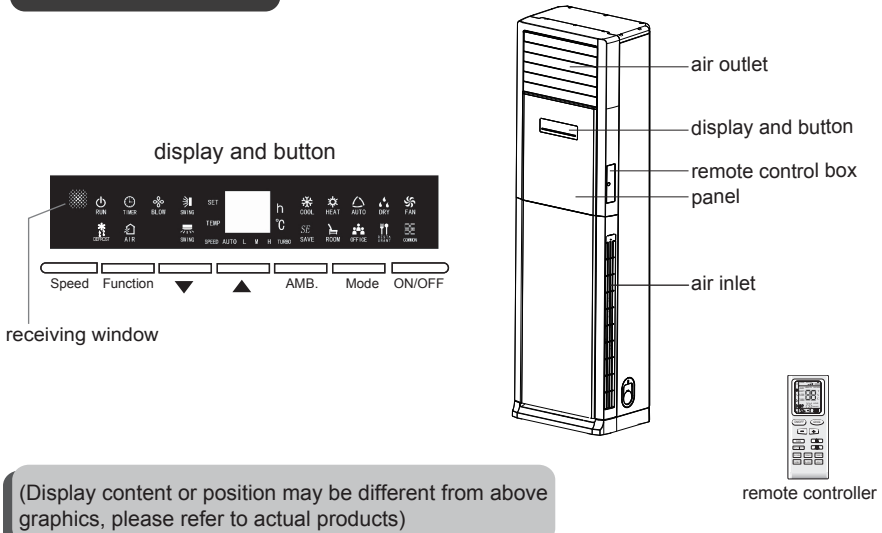

## Outdoor Unit

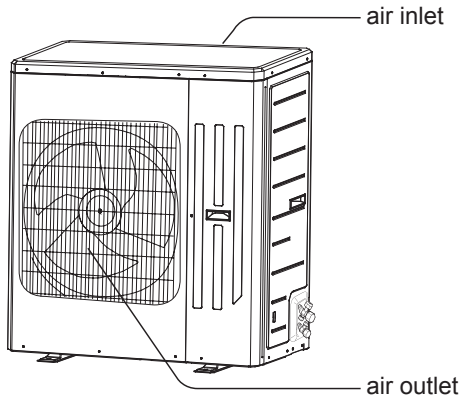

### **NOTICE:**

Actual product may be different from above graphics, please refer to actual products.



# Button's Name and Function

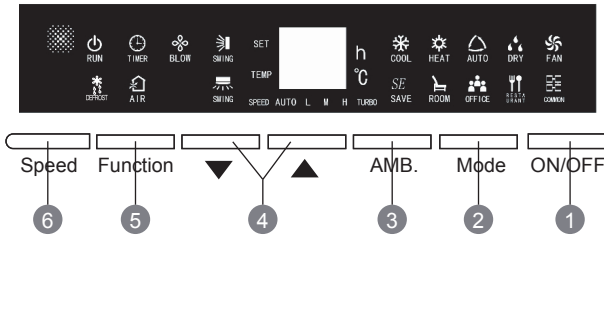

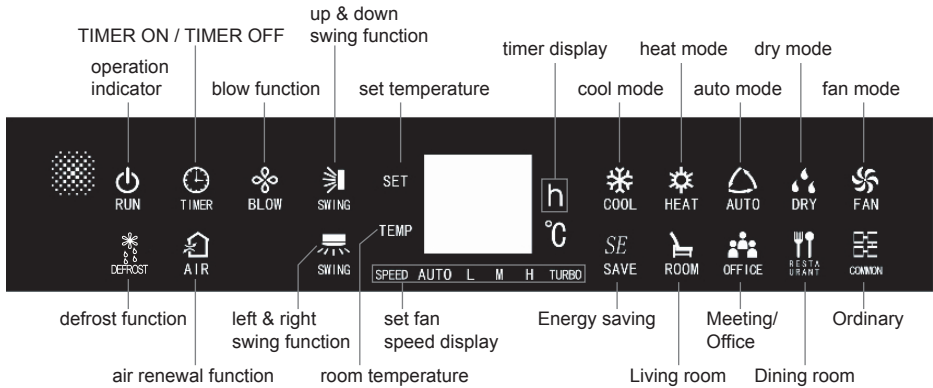

- 1 ON/OFF button
- 2 Mode button
- 3 AMB. button
- 4 ▼/▲ button
- 5 Function
- 6 Speed

# Introduction for icons on display screen of air conditioner





# Button's introduction

## Caution:

- After putting through the power, the air conditioner will give out a sound. Operation indicator “” is ON (red indicator). After that, you can operate the air conditioner by the control panel.
- Under ON status, after each pressing of button on control panel, icons on display screen will ON. (Except functional button setting, please refer to related description of functional buttons for details) Air conditioner will also give out sound.
- Under OFF status, only operation indicator “” is ON (red indicator).

## 1 ON/OFF button

- Press this button to turn on or turn off the air conditioner.
- After the unit is started up. “” is in green (Display color may be different for different unit, please refer to the actual product). Under standby status, “” is in red.

## 2 MODE button

- Press this button and the mode will change circularly as below:

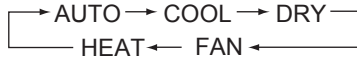

**AUTO:** Under this mode, air conditioner will operate automatically according to ambient temperature. Set temperature can't be adjusted. “” icon is bright.

**COOL:** Under this mode, air conditioner will operate under cool mode. “” icon is bright.

**DRY:** Under this mode, air conditioner operates at low speed under dry mode. Fan speed can't be adjusted. “” icon is bright.

**FAN:** Under this mode, air conditioner can't cool or heat, only blow fan. “” icon is bright.

**HEAT:** Under this mode, air conditioner will operate under heat mode. “” icon is bright.

(Note: Heat mode is not available for cooling only unit.)

## 3 AMB. button (Ambient button)

- Press this button, and ambient mode will be changed circularly as below:

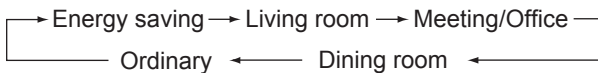

- Setting method of ambient mode:

For the first time unit is started, ambient mode defaults to ordinary mode. Turn off the unit and start it up again, ambient mode will remain the set status before unit is turned off. Air conditioner can only be switched into energy saving mode or ordinary mode under ambient mode after receiving signals from remote controller. Under the mode of energy saving, living room, meeting/office or dining room,

# Button's introduction

sleep function will be canceled automatically and can't be set. Sleep function is only effective in cooling, drying or heating under ordinary mode.

- Under mode of living room, dining room, meeting/office, set temperature, set speed, up & down swing and left & right swing will be adjusted automatically. If user changes the set temperature, set speed or up & down swing, air conditioner will run according to user's setting. Next time when unit is turned on, up & down swing and left & right swing will maintain the previous status while temperature and fan speed adopt default settings.
- Under energy saving mode, when unit is in cooling operation, set temperature, set speed, up & down swing and left & right swing will be adjusted automatically. If user changes the fan speed, up & down swing or left & right swing, air conditioner will run according to user's setting. Temperature can't be set under energy saving mode.
- The mode of living room, dining room, meeting/office can only be set via the front panel of air conditioner. If air conditioner receives signal from remote controller under the mode of living room, dining room, meeting/office, it will exit the above-said modes and run according to the signal from remote controller.

## 4 “▲” or “▼” button

- Temperature adjustment: After each pressing of “▲” or “▼” button, set temperature will increase or decrease 1 °C. Temperature adjustment range is 16 °C-30 °C. Under auto mode, temperature setting button is invalid.
- Function selection: You can press “▲” and “▼” button to select your required function to select your required function.
- Lock screen: press “▲” and “▼” buttons at the same time for 3s, all buttons on display panel will be locked. Meanwhile, display board displays “LC” to warning user that buttons are locked. Press “▲” and “▼” buttons at the same time for 3s again to unlock buttons, and display will resume normal.
- Test: After energization for the first time, when there's no button-pressing: Press ▲ button for twice successively within 20s, the unit operates under compulsory heating. Up&down swing blade opens to the minimum position, and all loads are turned on. Indoor fan and outdoor fan operate at high speed. All characters will be displayed when there's no malfunction of temperature sensor. When there's malfunction of temperature sensor, dual-8nixie tube displays error code in turn and the buzzer gives sound. The unit will stop operation after 5min or if the unit received the OFF signal within 5s, the unit will turn to standby status. Or press ▼ button for twice successively within 20s and the unit will operate at compulsory cooling at once. Up&down swing blade opens to the minimum position, and all loads are turned on except the 4-way valve. Indoor fan and outdoor fan operate at high speed. All characters will be displayed when there's no malfunction of temperature sensor. When there's malfunction of temperature sensor, dual-8nixie tube displays error code in turn and the buzzer gives sound.

# Button's introduction

The unit will stop operation after 5min or if the unit received the OFF signal within 5s, the unit will turn to standby status.

(Energization for the first time: it indicates the first energization after installing the unit)

## 5 FUNCTION button

- Under ON status, press this button select up&down swing, left&right swing, blow (X-fan), timer, air renewal, display set temperature and display indoor ambient temperature function.
  - a. When function character on display flashes, it indicates you can use “▲” or “▼” button to set function.
  - b. If there's no change after function is set for 5s, the setting is finished.
  - c. After setting function, if the unit hasn't be turned off and hasn't received remote control signal within 2min, press this button to circulate the function from current setting function. After 2min, if turn off the unit by pressing ON/OFF button or the unit received the remote control signal, press this button again and the function will circulate from the first function icon.
- When pressing this button to select up&down swing function, the corresponding icon flashes. Meanwhile, press “▲” or “▼” button can start up or turn off up&down swing.
- When pressing this button to select left&right swing function, the corresponding icon flashes. Meanwhile, press “▲” or “▼” button can start up or turn off left&right swing.
- When blow (X-fan) function is started up, after the air condition is turned off, indoor fan will continue to operate at low speed for a period of time. After turning off the unit, when indoor fan operates, press this button can turn off the air conditioner directly. (After turning off the unit, when indoor fan is operates, press this button can't set TIMER ON.)
- Timer function:
  - a. Under ON status: press this button to select timer function and corresponding icon will flash. Meanwhile, TIMER OFF can be set. Dual-8 nixie tube displays timer value and “h” will be displayed. Each pressing of “▲” or “▼” button can increase/decrease 0.5h or 1h. (When the time is within 10h, each pressing of “▲” or “▼” button will increase or decrease 0.5h; when the time is among 10-24h, each pressing of “▲” or “▼” button will increase or decrease 1h). After time is set, wait for 5s or press this button to select next function can startup TIMER OFF. Cancel Timer OFF: Under timer function, press this button to select timer function and the corresponding icon flashes. Meanwhile, press “▲” or “▼” button to adjust timer setting to no display, wait for 5s or press this button to select next function can cancel TIMER OFF.

## Button's introduction

b. Under OFF status: Press this can set TIMER ON directly. Dual-8 nixie tube displays timer value and "h" will be displayed. Each pressing of "▲" or "▼" button can increase/decrease 0.5h or 1h. (When the time is within 10h, each pressing of "▲" or "▼" button will increase or decrease 0.5h; when the time is among 10-24h, each pressing of "▲" or "▼" button will increase or decrease 1h). After time is set, wait for 5s or press this button can startup TIMER ON.

Cancel Timer ON: Press this button and the corresponding icon flashes. Meanwhile, press "▲" or "▼" button to adjust timer setting to no display, wait for 5s or press this button can cancel TIMER ON.

c. Time setting range: 0.5-24h.

- Press this button to select set temperature display function, and "SET" figure flashes. Meanwhile, press "▲" or "▼" button and set temperature will be defaulted to display.
- Press this button to select indoor ambient temperature display function, "TEMP" figures flashes. Meanwhile, press "▲" or "▼" button and indoor ambient temperature will be defaulted to display.
- Air renewal function is not available for this unit.

### **6** SPEED button

- When pressing this button, fan speed will switch among "auto→low→medium→high→turbo→auto" circularly. (Low speed under drying mode and this button is invalid for drying mode. "Turbo" is available for cool mode and heat mode; is not available for auto mode and fan mode; "Turbo" cannot be set under Dry mode)

# Buttons on remote controller

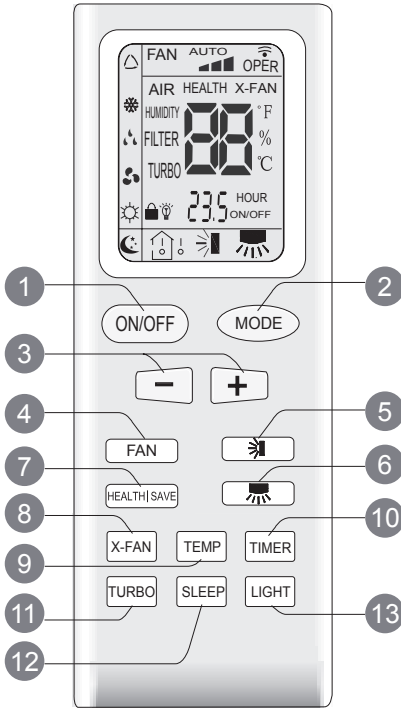

- 1 ON/OFF button
- 2 MODE button
- 3 +/- button
- 4 FAN button
- 5 button
- 6 button
- 7 HEALTH|SAVE button
- 8 X-FAN button  
(Note: X-FAN is the same with BLOW.)
- 9 TEMP button
- 10 TIMER button
- 11 TURBO button
- 12 SLEEP button
- 13 LIGHT button

# Introduction for icons on display screen of remote controller

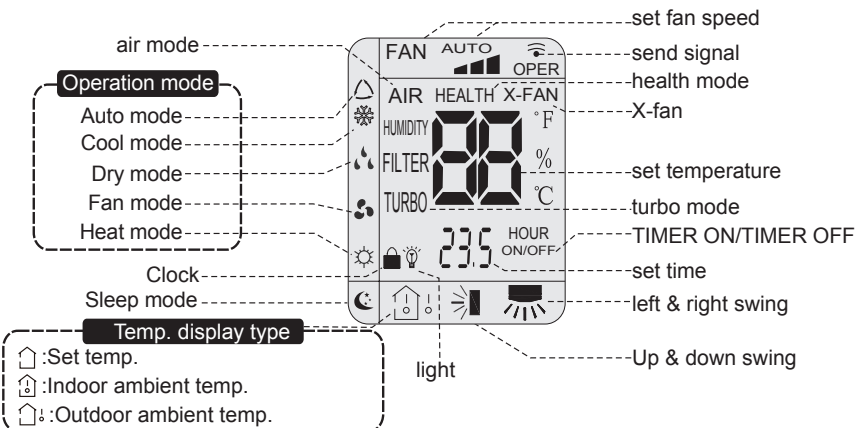

# Introduction for buttons on remote controller

## Note:

- After putting through power, air conditioner will give out a sound and operation indicator "⏻" is ON (red indicator). You can operate the air conditioner through the remote controller.
- At ON status, after each pressing button on remote controller, the signal icon "📶" on remote controller will flash once. Air conditioner will give out a sound, which indicates the signal has been sent to air conditioner.
- At OFF status, display screen on remote controller displays set temperature. At on status, display screen on remote controller displays the corresponding startup function's icon.

## 1 ON/OFF button

Press this button can turn on or turn off the air conditioner. After turning on the unit, operation indicator "⏻" on indoor unit is ON (green indicator. Color may be different for different models)and indoor unit gives out a sound.

## 2 MODE button

Press this button can select your required operation mode.

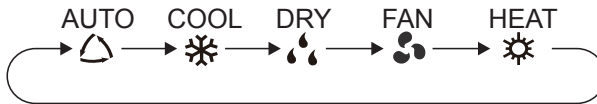

- After selecting auto mode, air conditioner will operate automatically according to ambient temperature. Set temperature can't be adjusted and also can't be displayed. Press "FAN" button can adjust fan speed. Press "🌀" button and "📶" button can adjust swing angle.
- After selecting cool mode, air conditioner operates under cool mode. Cool indicator "❄️" on indoor unit is ON. You can press "+" or "-" button to adjust set temperature. Press "FAN" button can adjust fan speed. Press "🌀" button and "📶" button can adjust swing angle.
- After selecting dry mode, air conditioner operates under dry mode at low speed. Dry indicator "💧" on indoor unit is ON. Under dry mode, fan speed can't be adjusted. Press "🌀" button and "📶" button to adjust swing angle.
- After selecting fan mode, air conditioner operates only under fan mode, All mode indicators on indoor unit is OFF. Operation indicator is on. Press "FAN" button can adjust fan speed. Press "🌀" button and "📶" button to adjust swing angle.
- After selecting heat mode, air conditioner operates under heat mode. Heat indicator "☀️" on indoor unit is ON. You can press "+" or "-" button to adjust set temperature. Press "FAN" button to adjust fan speed. Press "🌀" button and "📶" button to adjust swing angle. (Cooling only unit can't receive the signal for heating mode.)

# Introduction for buttons on remote controller

## Note:

For preventing cold wind, after starting up heating mode, indoor fan will blow fan after delaying 1-5min. (Details time is decided by indoor ambient temperature)  
Temperature setting range on remote controller: 16°C -30°C . Fan speed setting range: auto, low speed, medium speed and high speed.

## 3 "+" or "-" button

- After each pressing of "+" or "-" button, it can increase or decrease set temperature 1°C . Hold "+" or "-" button, 2s later, set temperature on remote controller will change quickly. After reaching to your required time, loosen the button. Temperature indicator on indoor unit will also change accordingly. (Temperature can't be adjusted under auto mode)
- Under TIMER ON, TIMER OFF or Clock setting, you can press "+" or "-" button to adjust time. (Refer to TIMER button for details)

## 4 FAN button

Pressing this button can set fan speed circularly as: auto (AUTO), low( ▲ ), medium ( ▲▲ ), high( ▲▲▲ ).



## Note:

- Under AUTO Speed, IDU fan motor will adjust the fan speed (high, medium or low speed) according to ambient temperature.
- Fan speed under dry mode is low speed.

## 5 扇形按钮 button

Press this button can select up&down swing. Swing angle can be selected in sequence as below:

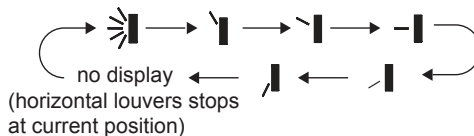

When selecting "扇形按钮" with remote controller, it's auto swing. Horizontal louver of air conditioner will swing up&down automatically at the maximum angle.

When selecting "┘", "┙", "┘", "┙", "┘" with remote controller, it's the fixed position swing. Horizontal louver of air conditioner will stop at that position as shown by the icon to swing.







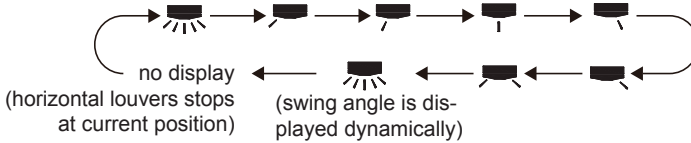

# Introduction for buttons on remote controller

## 6 button

Press this button can select left&right swing. Swing angle can be selected circularly in sequence as below:



- When selecting "", it's auto swing. Horizontal louver of air conditioner will swing left&right automatically at the maximum angle.
- When selecting ", , , , " with remote controller, it's the fixed position swing. Horizontal louver of air conditioner will stop at that position as shown by the icon to swing.
- When selecting "", it's the circulating swing. Horizontal louver of air conditioner will swing left&right automatically according to the angle as shown by the icon.  
(swing angle is displayed dynamically)

## 7 HEALTH|SAVE button

### HEALTH function:

After pressing HEALTH button, remote controller will switch circularly as below:  
"HEALTH"→"AIR"→"AIR HEALTH"→"no display"

- When selecting "HEALTH" by remote controller, HEALTH function will be started up.
- When selecting "AIR" by remote controller, AIR function will be started up.
- When selecting "AIT HEALTH", AIR and HEALTH function will be started up.
- When there's no display on remote controller, AIR and HEALTH function will be turned off.
- AIR function is applicable for some models.
- HEALTH function is applicable to partial of models.

### SAVE function:

Under cool mode, press SAVE button and the unit will operate under SAVE mode. Dual-8nixie tube on remote controller displays "SE". Air conditioner will operate at auto speed. Set temperature can't be adjusted. Press SAVE button again to exit SAVE mode. Air conditioner turn back to original set speed and set temperature.

- This function is applicable to partial of models.

## 8 X-FAN button

After pressing this button under cooling or dry mode, remote controller displays the character of "X-FAN" and X-FAN function is started up. Press this button again to cancel X-FAN function. The character of "X-FAN" will disappear.

### Note:

- After starting up X-FAN function, when turning off the unit, indoor fan will continue

# Introduction for buttons on remote controller

to operate for a while at low speed to dry the residual water inside the indoor unit.

- When the unit operates under X-FAN mode, press "X-FAN" button can turn off X-FAN function. Indoor fan stops operation immediately.

## 9 TEMP button

Press this button can see indoor set temperature, indoor ambient temperature or outdoor ambient temperature on indoor unit's display. Temperature is set circularly by remote controller as below:

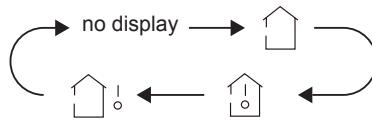

- When selecting "🏠" by remote controller or no display, temperature indicator on indoor unit displays set temperature.
- When selecting "🏠⦿" by remote controller, temperature indicator on indoor unit displays indoor ambient temperature.
- When selecting "🏠⦿!" by remote controller, temperature indicator on indoor unit displays outdoor ambient temperature.

### Note:

- Outdoor ambient temperature display may can't be selected for some models. When indoor unit receives "🏠⦿!" signal, it displays indoor ambient temperature.
- Only for the model whose indoor unit has dual-8 display.

## 10 TIMER button

- At ON status, press this button once can set TIMER OFF. The character of HOUR and OFF will flash. Press "+" or "-" button within 5s can adjust the time of TIMER ON. After each pressing of "+" or "-" button, time will increase or decrease half an hour. When holding "+" or "-" button, 2s later, the time will change quickly until to reach to your required time. After that, press "TIMER" button to confirm it. The character of HOUR and OFF won't flash again.  
Cancel TIMER OFF: Press "TIMER" button again under TIMER OFF status.
- At OFF status, press this button once can set TIMER ON. Please refer to TIMER off for detailed operation.  
Cancel TIMER ON: Press "TIMER" button again under TIMER ON status.

### Note:

- Time setting range: 0.5-24 hours.
- Time interval between two operations can't exceed 5s. Otherwise, remote controller will exit the setting status automatically.

## Introduction for buttons on remote controller

### 11 TURBO button

When pressing this button under cooling or heating mode, air conditioner will enter into quick cooling or quick heating mode. The character of "TURBO" is displayed on remote controller. Press this button again to exit turbo function and the character of "TURBO" will be disappeared on remote controller.

### 12 SLEEP button

Press this button under cooling, heating mode can start up sleep function. "☾" icon will be displayed on remote controller. Press this button again to cancel sleep function. "☾" icon on remote controller will be displayed.

### 13 LIGHT button





Press this button can turn off the light for indoor unit's display. "💡" icon on remote controller will disappear. Press this button again to turn on the light for indoor unit's display. "💡" icon on remote controller will be displayed.

## Function introduction for combination buttons

### Child lock function

Press "+" and "-" buttons simultaneously can turn on or turn off child lock function. When child lock function is started up, "🔒" icon will be displayed on remote controller. If operate remote controller, "🔒" icon will flash three times, while remote controller won't send signal.

## Operation guide

1. After putting through the power, press "  " button on remote controller to turn on the air conditioner.
2. Press "  " button to select your required mode: AUTO, COOL, DRY, FAN, HEAT.
3. Press "+" or "-" button to set your required temperature. (Temperature can't be adjusted under auto mode).
4. Press "  " button to set your required fan speed: auto, low, medium and high speed.
5. Press "  " and "  " button to select fan blowing angle.

## Replacement of batteries in remote controller

1. Press the back side of remote controller marked with "  ", as shown in the fig, and then push out the cover of battery box along the arrow direction.
2. Replace two 7# (AAA 1.5V) dry batteries, and make sure the position of "+" polar and "-" polar are correct.
3. Reinstall the cover of battery box.

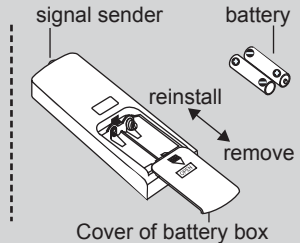

### Note:

- During operation, point the remote control signal sender at the receiving window on indoor unit.
- The distance between signal sender and receiving window should be no more than 8m, and there should be no obstacles between them.
- Signal may be interfered easily in the room where there is fluorescent lamp or wireless telephone; remote controller should be close to indoor unit during operation.
- Replace new batteries of the same model when replacement is required.
- When you don't use remote controller for a long time, please take out the batteries.
- If the display on remote controller is fuzzy or there's no display, please replace batteries.

# Clean and maintenance

## Note:

- Turn off the air conditioner and disconnect the power before cleaning the air conditioner to avoid electric shock.
- Do not wash the air conditioner with water to avoid electric shock.
- Do not use volatile liquid to clean the air conditioner.

## Clean surface of indoor unit

When the surface of indoor unit is dirty, it is recommended to use a soft dry cloth or wet cloth to wipe it.

## Note:

- Do not remove the panel when cleaning it.

## Clean filter

### 1. Remove screws of air-in panel

Open screw caps at both sides according to direction ① in fig. 1. Remove the screws at both sides of air-in panel with screwdriver.

### 2. Open the air-in panel

According the arrow direction ① in fig. 2. Draw out the filter according to arrow direction ②.

### 3. Clean filter

- Use dust catcher or water to clean the filter.
- When the filter is very dirty, use water (below 45 ℃) to clean it, and then put it in a shady and cool place to dry.

### 4. Install filter and air-in panel

After installing the filter, buckle the air-in panel. Use screwdriver to tighten the screws at both sides of air-in panel, and then install the screw cap.

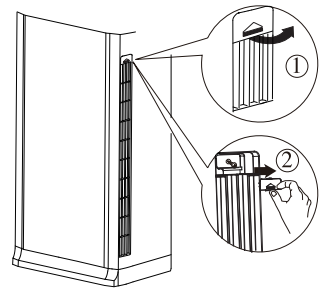

Fig. 1

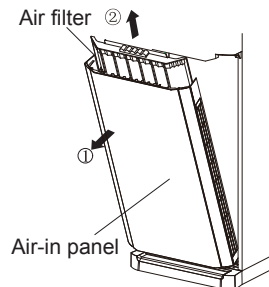
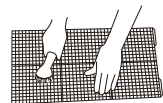

Fig. 2



## Note:

- The filter should be cleaned every three months. If there is much dust in the operation environment, cleaning frequency can be increased.
- Do not use fire or hair dryer to dry the filter to avoid deformation or fire hazard.

## Clean and maintenance

### **NOTICE: Checking before use-season**

1. Check whether air inlet and air outlet are blocked.
2. Check whether air switch, plug and socket are in good condition.
3. Check whether filter is clean.
4. Check whether the remote controller is installed with batteries.
5. Check whether mounting bracket for outdoor unit is damaged or corroded. If yes, please contact dealer.
6. Check whether drainage pipe is damaged.

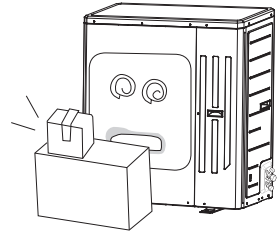

### **NOTICE: Checking after use-season**

1. Disconnect power supply.
2. Clean filter and indoor unit's panel.
3. Clear dust and obstructions from the outdoor unit.
4. Check whether mounting bracket for outdoor unit is damaged or corroded. If yes, please contact dealer.

### **Notice for recovery**

1. Many packing materials are recyclable materials. Please dispose them in appropriate recycling unit.
2. If you want to dispose the air conditioner, please contact local dealer or consultant service center for the correct disposal method.

# Malfunction

## General phenomenon analysis

Please check below items before asking for maintenance. If the malfunction still can't be eliminated, please contact local dealer or qualified professionals.

| Phenomenon   | Check items  | Solution   |
|--|--|--|
| Indoor unit can't receive remote controller's signal or remote controller has no action. | <ul style="list-style-type: none"> <li>Whether it's interfered severely (such as static electricity, stable voltage)?</li> </ul> | <ul style="list-style-type: none"> <li>Pull out the plug. Reinsert the plug after about 3min, and then turn on the unit again.</li> </ul>                        |
|  | <ul style="list-style-type: none"> <li>Whether remote controller is within the signal receiving range?</li> </ul>                | <ul style="list-style-type: none"> <li>Signal receiving range is 8m.</li> </ul>  |
|  | <ul style="list-style-type: none"> <li>Whether there are obstacles?</li> </ul>   | <ul style="list-style-type: none"> <li>Remove obstacles.</li> </ul>  |
|  | <ul style="list-style-type: none"> <li>Whether remote controller is pointing at the receiving window?</li> </ul>                 | <ul style="list-style-type: none"> <li>Select proper angle and point the remote controller at the receiving window on indoor unit.</li> </ul>                    |
|  | <ul style="list-style-type: none"> <li>Is sensitivity of remote controller low; fuzzy display and no display?</li> </ul>         | <ul style="list-style-type: none"> <li>Check the batteries. If the power of batteries is too low, please replace them.</li> </ul>                                |
|  | <ul style="list-style-type: none"> <li>No display when operating remote controller?</li> </ul>                                   | <ul style="list-style-type: none"> <li>Check whether remote controller appears to be damaged. If yes, replace it.</li> </ul>                                     |
|  | <ul style="list-style-type: none"> <li>Fluorescent lamp in room?</li> </ul>  | <ul style="list-style-type: none"> <li>Take the remote controller close to indoor unit.</li> <li>Turn off the fluorescent lamp and then try it again.</li> </ul> |
| Air conditioner can't operate  | <ul style="list-style-type: none"> <li>Power failure?</li> </ul>   | <ul style="list-style-type: none"> <li>wait until power recovery.</li> </ul>   |
|  | <ul style="list-style-type: none"> <li>Is plug loose?</li> </ul>   | <ul style="list-style-type: none"> <li>Reinsert the plug.</li> </ul>   |
|  | <ul style="list-style-type: none"> <li>Air switch trips off or fuse is burnt out?</li> </ul>                                     | <ul style="list-style-type: none"> <li>Ask professional to replace air switch or fuse.</li> </ul>  |
|  | <ul style="list-style-type: none"> <li>Wiring has malfunction?</li> </ul>  | <ul style="list-style-type: none"> <li>Ask professional to replace it.</li> </ul>  |
|  | <ul style="list-style-type: none"> <li>Unit has restarted immediately after stopping operation?</li> </ul>                       | <ul style="list-style-type: none"> <li>Wait for 3min, and then turn on the unit again.</li> </ul>  |
|  | <ul style="list-style-type: none"> <li>Whether the function setting for remote controller is correct?</li> </ul>                 | <ul style="list-style-type: none"> <li>Reset the function.</li> </ul>  |

# Malfunction

| Phenomenon                                    | Check items   | Solution  |
|---|---|---|
| Mist is emitted from indoor unit's air outlet | <ul style="list-style-type: none"> <li>Indoor temperature and humidity is high?</li> </ul>                              | <ul style="list-style-type: none"> <li>Because indoor air is cooled rapidly. After a while, indoor temperature and humidity will be decrease and mist will disappear.</li> </ul>          |
| No air emitted from indoor unit               | <ul style="list-style-type: none"> <li>Air inlet or air outlet of indoor unit is blocked?</li> </ul>                    | <ul style="list-style-type: none"> <li>Eliminate obstacles.</li> </ul>  |
|   | <ul style="list-style-type: none"> <li>Under heating mode, indoor temperature is reached to set temperature?</li> </ul> | <ul style="list-style-type: none"> <li>After reaching to set temperature, indoor unit will stop blowing out air.</li> </ul>   |
|   | <ul style="list-style-type: none"> <li>Heating mode is turned on just now?</li> </ul>                                   | <ul style="list-style-type: none"> <li>In order to prevent blowing out cold air, indoor unit will be started after delaying for several minutes, which is a normal phenomenon.</li> </ul> |
| Set temperature can't be adjusted             | <ul style="list-style-type: none"> <li>Unit is operating under auto mode?</li> </ul>                                    | <ul style="list-style-type: none"> <li>Temperature can't be adjusted under auto mode. Please switch the operation mode if you need to adjust temperature.</li> </ul>                      |
|   | <ul style="list-style-type: none"> <li>Your required temperature exceeds the set temperature range?</li> </ul>          | <ul style="list-style-type: none"> <li>Set temperature range: 16°C~30°C.</li> </ul>   |
| Cooling (heating) effect is not good.         | <ul style="list-style-type: none"> <li>Voltage is too low?</li> </ul>   | <ul style="list-style-type: none"> <li>Wait until the voltage resumes normal.</li> </ul>  |
|   | <ul style="list-style-type: none"> <li>Filter is dirty?</li> </ul>  | <ul style="list-style-type: none"> <li>Clean the filter.</li> </ul>   |
|   | <ul style="list-style-type: none"> <li>Set temperature is in proper range?</li> </ul>                                   | <ul style="list-style-type: none"> <li>Adjust temperature to proper range.</li> </ul>   |
|   | <ul style="list-style-type: none"> <li>Door and window are open?</li> </ul>   | <ul style="list-style-type: none"> <li>Close door and window.</li> </ul>  |
| Odours are emitted                            | <ul style="list-style-type: none"> <li>Whether there's odour source, such as furniture and cigarette, etc.</li> </ul>   | <ul style="list-style-type: none"> <li>Eliminate the odour source.</li> </ul>   |
|   |   | <ul style="list-style-type: none"> <li>Clean the filter.</li> </ul>   |



# Malfunction

| Phenomenon                                 | Check items   | Solution   |
|--|---|--|
| Air conditioner operates normally suddenly | <ul style="list-style-type: none"><li>• Whether there's interference, such as thunder, wireless devices, etc.</li></ul> | <ul style="list-style-type: none"><li>• Disconnect power, put back power, and then turn on the unit again.</li></ul>   |
| Outdoor unit has vapor                     | <ul style="list-style-type: none"><li>• Heating mode is turned on?</li></ul>  | <ul style="list-style-type: none"><li>• During defrosting under heating mode, it may generate vapor, which is a normal phenomenon.</li></ul>                                     |
| "Water flowing" noise                      | <ul style="list-style-type: none"><li>• Air conditioner is turned on or turned off just now?</li></ul>                  | <ul style="list-style-type: none"><li>• The noise is the sound of refrigerant flowing inside the unit, which is a normal phenomenon.</li></ul>                                   |
| Cracking noise                             | <ul style="list-style-type: none"><li>• Air conditioner is turned on or turned off just now?</li></ul>                  | <ul style="list-style-type: none"><li>• This is the sound of friction caused by expansion and/or contraction of panel or other parts due to the change of temperature.</li></ul> |

# Malfunction

## Error code

- When air conditioner status is abnormal, temperature indicator on indoor unit will blink to display corresponding error code. Please refer to below list for identification of error code.

| Error code | Troubleshooting   |
|------------|---|
| E1         | It can be eliminated after restarting the unit. If not, please contact qualified professionals to deal with it. |
| E3         | It can be eliminated after restarting the unit. If not, please contact qualified professionals to deal with it. |
| E4         | It can be eliminated after restarting the unit. If not, please contact qualified professionals to deal with it. |
| E5         | It can be eliminated after restarting the unit. If not, please contact qualified professionals to deal with it. |
| F1         | Please contact qualified professionals to deal with it.   |
| F2         | Please contact qualified professionals to deal with it.   |
| F3         | Please contact qualified professionals to deal with it.   |
| F4         | Please contact qualified professionals to deal with it.   |
| F5         | Please contact qualified professionals to deal with it.   |

Note: If there're other error codes, please contact qualified professionals for service.

## Warning

- When below phenomenon occurs, please turn off air conditioner and disconnect power immediately, and then contact the dealer or qualified professionals for service.
  - Power cord is overheating or damaged.
  - There's abnormal sound during operation.
  - Air switch trips off frequently.
  - Air conditioner gives off burning smell.
  - Indoor unit is leaking.
- Do not repair or refit the air conditioner by yourself.
- If the air conditioner operates under abnormal conditions, it may cause malfunction, electric shock or fire hazard.

# Installation dimension diagram

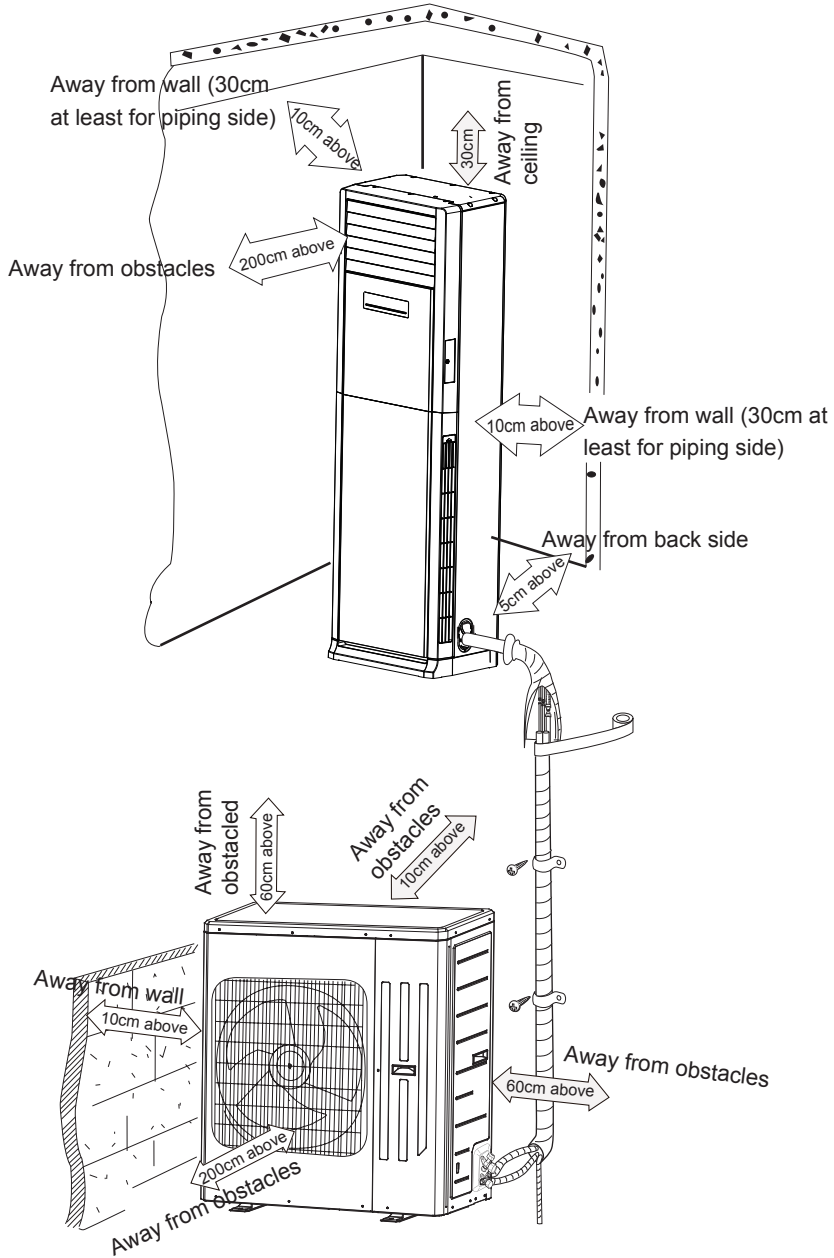

# Safety precautions for installing and relocating the unit

To ensure safety, please be mindful of the following precautions.

## Warning

- **When installing or relocating the unit, be sure to keep the refrigerant circuit free from air or substances other than the specified refrigerant.**  
Any presence of air or other foreign substance in the refrigerant circuit will cause system pressure rise or compressor rupture, resulting in injury.
- **When installing or moving this unit, do not charge the refrigerant which is not comply with that on the nameplate or unqualified refrigerant.**  
Otherwise, it may cause abnormal operation, wrong action, mechanical malfunction or even series safety accident.
- **When refrigerant needs to be recovered during relocating or repairing the unit, be sure that the unit is running in cooling mode. Then, fully close the valve at high pressure side (liquid valve). About 30-40 seconds later, fully close the valve at low pressure side (gas valve), immediately stop the unit and disconnect power. Please note that the time for refrigerant recovery should not exceed 1 minute.**  
If refrigerant recovery takes too much time, air may be sucked in and cause pressure rise or compressor rupture, resulting in injury.
- **During refrigerant recovery, make sure that liquid valve and gas valve are fully closed and power is disconnected before detaching the connection pipe.**  
If compressor starts running when stop valve is open and connection pipe is not yet connected, air will be sucked in and cause pressure rise or compressor rupture, resulting in injury.
- **When installing the unit, make sure that connection pipe is securely connected before the compressor starts running.**  
If compressor starts running when stop valve is open and connection pipe is not yet connected, air will be sucked in and cause pressure rise or compressor rupture, resulting in injury.
- **Prohibit installing the unit at the place where there may be leaked corrosive gas or flammable gas.**  
If there leaked gas around the unit, it may cause explosion and other accidents.
- **Do not use extension cords for electrical connections. If the electric wire is not long enough, please contact a local service center authorized and ask for a proper electric wire.**  
Poor connections may lead to electric shock or fire.
- **Use the specified types of wires for electrical connections between the indoor and outdoor units. Firmly clamp the wires so that their terminals receive no external stresses.**  
Electric wires with insufficient capacity, wrong wire connections and insecure wire terminals may cause electric shock or fire.

## Tools for installation

|                          |                   |                    |
|--------------------------|-------------------|--------------------|
| 1 Level meter            | 2 Screw driver    | 3 Impact drill     |
| 4 Drill head             | 5 Pipe expander   | 6 Torque wrench    |
| 7 Open-end wrench        | 8 Pipe cutter     | 9 Leakage detector |
| 10 Vacuum pump           | 11 Pressure meter | 12 Universal meter |
| 13 Inner hexagon spanner |                   | 14 Measuring tape  |

### Note:

- Please contact the local agent for installation.
- Don't use unqualified power cord.

## Selection of installation location

| Basic requirements  | Indoor unit   |
|---|---|
| <p>Installing the unit in the following places may cause malfunction. If it is unavoidable, please consult the local dealer:</p> <ol style="list-style-type: none"> <li>1. The place near strong heat sources vapors, flammable or explosive gas, or volatile objects spread in the air.</li> <li>2. The place with high-frequency devices (such as welding machine, medical equipment).</li> <li>3. The place near coast area.</li> <li>4. The place with oil or fumes in the air.</li> <li>5. The place with sulfureted gas.</li> <li>6. Other places with special circumstances.</li> <li>7. Please try your best to keep way from fluorescent lamp.</li> </ol>  | <ol style="list-style-type: none"> <li>1. Avoid installing the indoor unit in a place where generated or leaked inflammable gas will stay.</li> <li>2. Avoid installing the indoor unit in a moist place or in a place where oil may be splashed on the unit.</li> <li>3. Select a location where outlet air may reach each corner of the room.</li> <li>4. Select a location where connection pipe can be led to outdoor conveniently.</li> <li>5. Select a location where air inlet and outlet won't be blocked.</li> <li>6. Select a location with least affection of outdoor air.</li> <li>7. Select a location with firm and flat floor.</li> <li>8. Retain sufficient space for maintenance and installation.</li> <li>9. Ensure the installation meets the requirement of installation dimension diagram.</li> <li>10. Do not use the unit in the immediate surroundings of a laundry a bath a shower or a swimming pool.</li> </ol> |
| Outdoor unit  |   |
| <ol style="list-style-type: none"> <li>1. Select a location where the noise and outflow air emitted by the outdoor unit will not affect neighborhood.</li> <li>2. The location should be well ventilated and dry, in which the outdoor unit won't be exposed directly to sunlight or strong wind.</li> <li>3. The location should be able to withstand the weight of outdoor unit.</li> <li>4. Make sure that the installation follows the requirement of installation dimension diagram.</li> <li>5. Select a location which is out of reach for children and far away from animals or plants. If it is unavoidable, please add fence for safety purpose.</li> <li>6. The height difference between indoor unit and outdoor unit should be within 5m. The length of connection pipe should be within 10m.</li> </ol> |   |

# Requirements for electric connection

## Safety precaution

1. Must follow the electric safety regulations when installing the unit.
2. If the supply cord is damaged, it must be replaced by the manufacturer or its service agent or a similarly qualified person in order to avoid a hazard.
3. According to the local safety regulations, use qualified power supply circuit and air switch.
4. A air switch having a contact separation of at least 3mm in all poles should be fixed in fixed wiring.
5. The appliance shall be installed in accordance with national wiring regulation.
6. The air switch must have the functions of magnetic tripping and heat tripping in order to prevent short circuit or overload. Please install the air switch with suitable capacity according to the sheet below.
7. Make sure the power supply matches with the requirement of air conditioner. Unstable power supply or incorrect wiring may result in electric shock, fire hazard or malfunction. Please install proper power supply cables before using the air conditioner.
8. Properly connect the live wire, neutral wire and grounding wire of power socket.
9. Be sure to cut off the power supply before proceeding any work related to electric safety.
10. Do not put through the power before finishing installation.

## Grounding requirement

1. The air conditioner is first class electric appliance. It must be properly grounded with specialized grounding device by a professional. Please make sure it is always grounded effectively, otherwise it may cause electric shock.
2. The yellow-green wire in air conditioner is grounding wire, which can't be used for other purposes.
3. The grounding resistance should comply with national electric safety regulations.

| Air-conditioner | Air switch capacity |
|-----------------|---------------------|
| 48K             | 16A                 |

# Installation of indoor unit

## Step one: choosing installation location

Recommend the installation location to the client and then confirm it with the client.

## Step two: open piping hole

1. Choose the position of piping hole according to the direction of outlet pipe.
2. Open a piping hole with the diameter of  $\Phi 70$  on the selected outlet pipe position. In order to drain smoothly, slant the piping hole on the wall slightly downward to the outdoor side with the gradient of  $5-10^\circ$ .

### Note:

- Pay attention to dust prevention and take relevant safety measures when opening the hole.

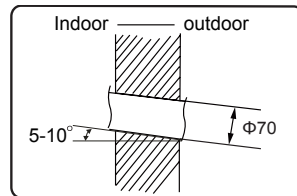

## Step three: outlet pipe

1. The pipe can be led out in the direction of left, right or rear.
2. After confirming the direction of outlet pipe, loosen the screws at the upper and lower adjusting baffle to let the connection pipe /drain pipe connects the indoor unit.

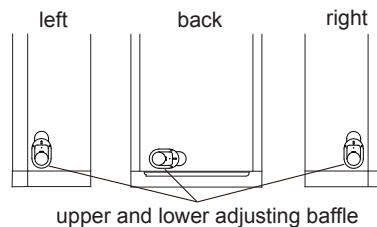
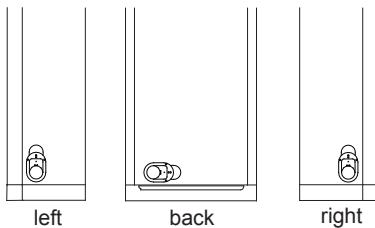

## Step four: connect the pipe of indoor unit

1. Take out the left and right screw cover and then remove the screws on air-inlet panel to remove the panel.

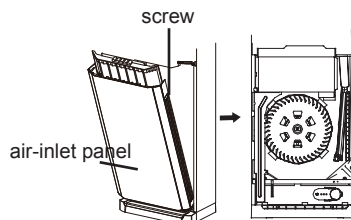

# Installation of indoor unit

2. Aim the pipe joint at the corresponding bellmouth.

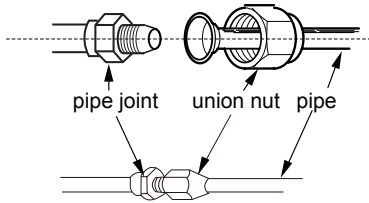

3. Pretightening the union nut with hand.
4. Adjust the torque force by referring to the following sheet. Place the open-end wrench on the pipe joint and place the torque wrench on the union nut. Tighten the union nut with torque wrench.

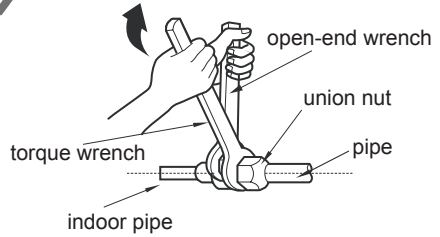

| Hex nut diameter(mm) | Tightening torque (N·m) |
|----------------------|-------------------------|
| Φ 6.35 (1/4")        | 15.7 (1.6kg·m)          |
| Φ 9.52 (3/8")        | 29.4 (3.0kg·m)          |
| Φ 12.70 (1/2")       | 49.0 (5.0kg·m)          |
| Φ 15.88 (5/8")       | 73.6 (7.5kg·m)          |

5. Wrap the indoor pipe and joint of connection pipe with insulating pipe, and then wrap it with tape.

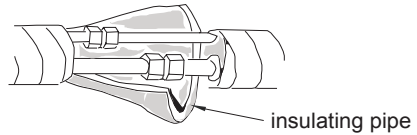

## Step five: install drain hose

1. Connect the drain hose to the outlet pipe of indoor unit.

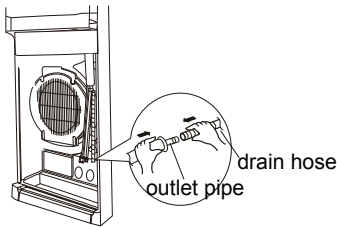

2. Bind the joint with tape.

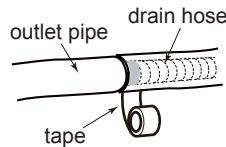

### Note:

- Add insulating pipe in the indoor drain hose in order to prevent condensation.

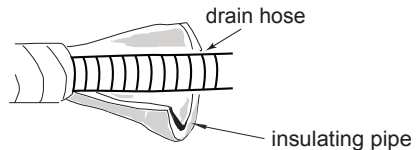

## Step six: connect wire of indoor unit

1. Make the power connection wire go through the cable-cross hole of indoor unit and then pull it out.

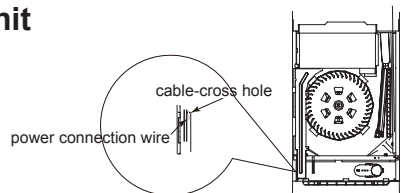



# Installation of indoor unit

2. Remove the wire clip; connect the power connection wire to the wiring terminal according to the color; tighten the screw and then fix the power connection wire with wire clip.

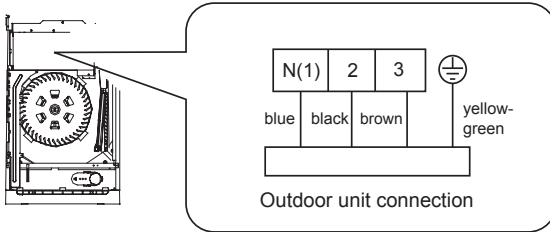

3. Adjust the position of upper and lower adjusting baffle; clamp the connection pipe and drain pipe as firm as possible.
4. Tighten the screws.

## Note:

All wires of indoor unit and outdoor unit should be connected by a professional.

- If the length of power connection wire is insufficient, please contact the supplier for a new one. Avoid extending the wire by yourself.
- For the air conditioner with plug, the plug should be reachable after finishing installation.
- For the air conditioner without plug, an air switch must be installed in the line. The air switch should be all-pole parting and the contact parting distance should be more than 3mm.

## Step seven: bind up pipe

1. Bind up the connection pipe, power cord and drain hose with the band.

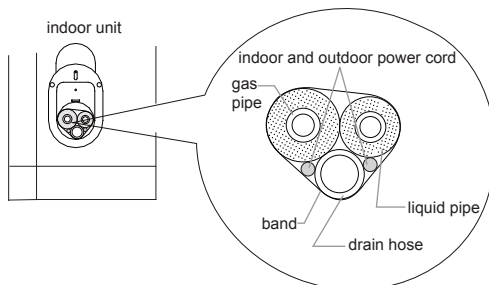

## Installation of indoor unit

2. Reserve a certain length of drain hose and power cord for installation when binding them. When binding to a certain degree, separate the indoor power and then separate the drain hose.

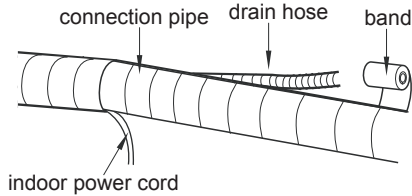

3. Wrap it evenly, and rolling width should be 1/3 of bandaging belt. Do not wrap it too tight or too loose.
4. The liquid pipe and gas pipe should be bound separately at the end.

### Note:

- The power cord and control wire can't be crossed or winding.
- The drain hose should be bound at the bottom.

---

## Step eight: place the indoor unit

1. Put the bound pipes in the wall pipe and then make them pass through the wall hole.
2. Stuff the gap between pipes and wall hole with sealing gum.
3. Fix the wall pipe.

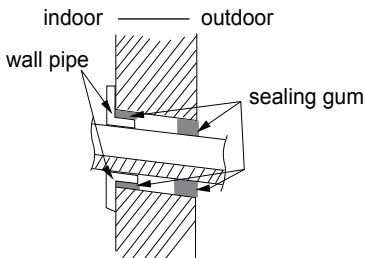

### Note:

- Do not bend the drain hose too excessively in order to prevent blocking.

# Installation of outdoor unit

## Step one: fix the support of outdoor unit

(select it according to the actual installation situation)

1. Select installation location according to the house structure.
2. Fix the support of outdoor unit on the selected location with expansion screws.

### Note:

- Take sufficient protective measures when installing the outdoor unit.
- Make sure the support can withstand at least four times the unit weight.
- The outdoor unit should be installed at least 3cm above the floor in order to install drain joint.
- For the unit with cooling capacity of 2300W~5000W, 6 expansion screws are needed; for the unit with cooling capacity of 6000W~8000W, 8 expansion screws are needed; for the unit with cooling capacity of 10000W~16000W, 10 expansion screws are needed.

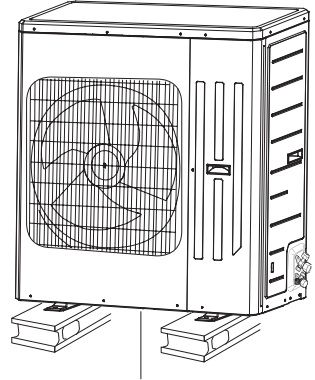

at least 3cm above the floor

## Step two: install drain joint (only for cooling and heating unit)

1. Connect the outdoor drain joint into the hole on the chassis, as shown in the picture below.

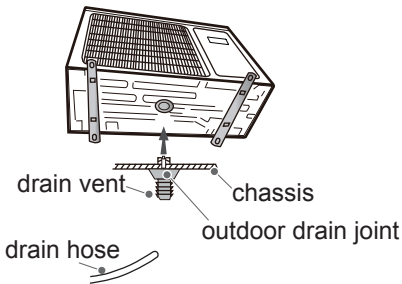

2. Connect the drain hose into the drain vent.

## Step three: fix outdoor unit

1. Place the outdoor unit on the support.
2. Fix the foot holes of outdoor unit with bolts.

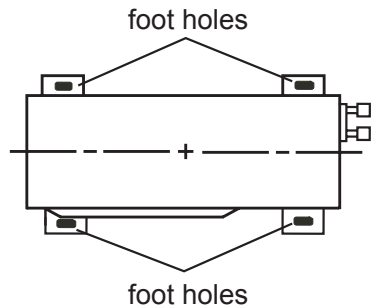

# Installation of outdoor unit

## Step four: connect indoor and outdoor pipes

1. Remove the front side plate or handle.

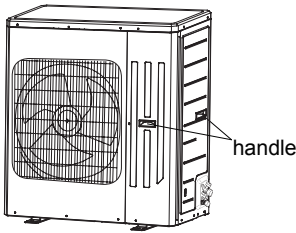

2. Remove the screw cap of valve and aim the pipe joint at the bellmouth of pipe.

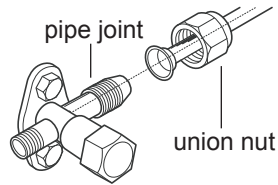
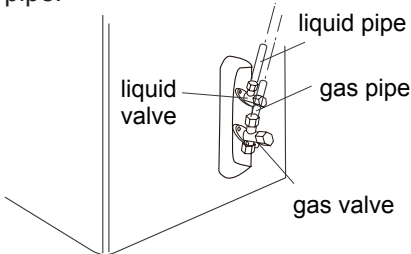

3. Pretightening the union nut with hand.

4. Tighten the union nut with torque wrench by referring to the sheet below.

| Hex nut diameter(mm) | Tightening torque (N·m) |
|----------------------|-------------------------|
| Φ 6.35 (1/4")        | 15.7 (1.6kg.m)          |
| Φ 9.52 (3/8")        | 29.4 (3.0kg.m)          |
| Φ 12.70 (1/2")       | 49 (5.0kg.m)            |
| Φ 15.88 (5/8")       | 73.6 (7.5kg.m)          |

## Step five: connect outdoor electric wire

1. Remove the wire clip; connect the power connection wire and signal control wire (only for cooling and heating unit) to the wiring terminal according to the color; fix them with screws.

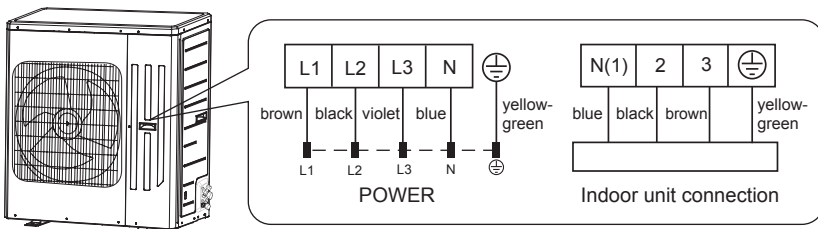

# Installation of outdoor unit

2. Fix the power connection wire and signal control wire with wire clip (only for cooling and heating unit).

## Note:

- After tightening the screw, pull the power cord slightly to check if it is firm.
- Never cut the power connection wire to prolong or shorten the distance.

## Step six: neaten the pipes

1. The pipes should be placed along the wall, bent reasonably and hidden possibly. Min. semidiameter of bending the pipe is 10cm.
2. If the outdoor unit is higher than the wall hole, you must set a U-shaped curve in the pipe before pipe goes into the room, in order to prevent rain from getting into the room.

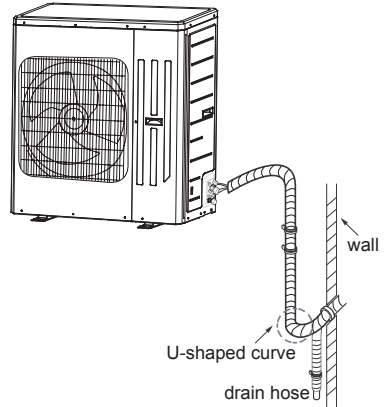

## Note:

- The through-wall height of drain hose shouldn't be higher than the outlet pipe hole of indoor unit.
- Slant the drain hose slightly downwards. The drain hose can't be curved, raised and fluctuant, etc.

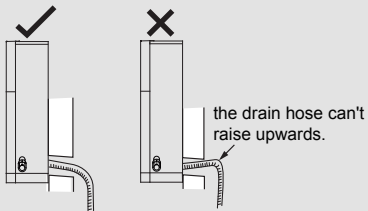

- The water outlet can't be placed in water in order to drain smoothly.

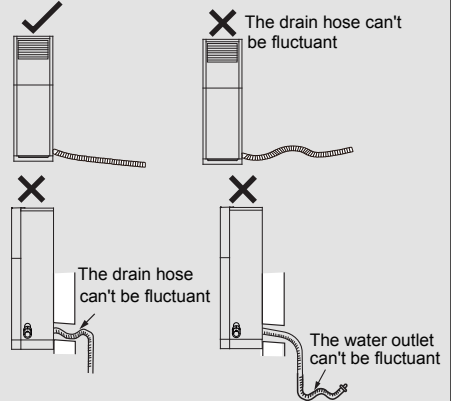
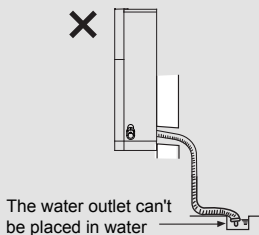

# Vacuum pumping

## Use vacuum pump

1. Remove the valve caps on the liquid valve and gas valve and the nut of refrigerant charging vent.
2. Connect the charging hose of piezometer to the refrigerant charging vent of gas valve and then connect the other charging hose to the vacuum pump.
3. Open the piezometer completely and operate for 10-15min to check if the pressure of piezometer remains in  $-0.1\text{MPa}$ .
4. Close the vacuum pump and maintain this status for 1-2min to check if the pressure of piezometer remains in  $-0.1\text{MPa}$ . If the pressure decreases, there may be leakage.
5. Remove the piezometer, open the valve core of liquid valve and gas valve completely with inner hexagon spanner.
6. Tighten the screw caps of valves and refrigerant charging vent.
7. Reinstall the handle.

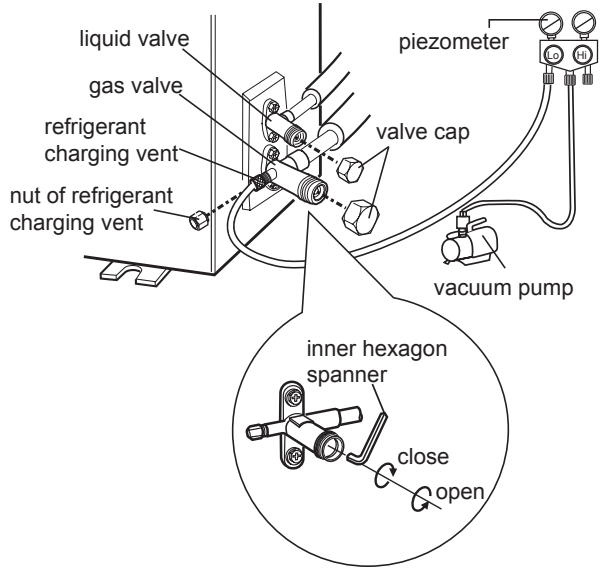

# Leakage detection

1. With leakage detector:  
Check if there is leakage with leakage detector.
2. With soap water:  
If leakage detector is not available, please use soap water for leakage detection. Apply soap water at the suspected position and keep the soap water for more than 3min. If there are air bubbles coming out of this position, there's a leakage.

## Check after installation

- Check according to the following requirement after finishing installation.

| Items to be checked  | Possible malfunction                                  |
|--|---|
| Has the unit been installed firmly?  | The unit may drop, shake or emit noise.               |
| Have you done the refrigerant leakage test?                                      | It may cause insufficient cooling (heating) capacity. |
| Is heat insulation of pipeline sufficient?                                       | It may cause condensation and water dripping.         |
| Is water drained well?   | It may cause condensation and water dripping.         |
| Is the voltage of power supply according to the voltage marked on the nameplate? | It may cause malfunction or damage the parts.         |
| Is electric wiring and pipeline installed correctly?                             | It may cause malfunction or damage the parts.         |
| Is the unit grounded securely?   | It may cause electric leakage.                        |
| Does the power cord follow specification?  | It may cause malfunction or damage the parts.         |
| Is there any obstruction in air inlet and air outlet?                            | It may cause insufficient cooling (heating).          |
| The dust and sundries caused during installation are removed?                    | It may cause malfunction or damage the parts.         |
| The gas valve and liquid valve of connection pipe are open completely?           | It may cause insufficient cooling (heating) capacity. |

## Test operation

### 1. Preparation of test operation

- The client approves the air conditioner installation.
- Specify the important notes for air conditioner to the client.

### 2. Method of test operation

- Put through the power, press ON/OFF button on the remote controller to start operation.
- Press MODE button to select AUTO, COOL, DRY, FAN and HEAT to check whether the operation is normal or not.
- If the ambient temperature is lower than 16 °C, the air conditioner can't start cooling.

# Installation instructions of anti-collapse chain

- In order to prevent accidental collapse of indoor unit, please install the anti-collapse chain.

Installation steps:

1. Remove the screw of anti-collapse hole at the top cover of indoor unit (see fig. 3);
2. Take out the anti-collapse chain and put it into the anti-collapse hole, and then tighten it with screw (see fig. 4);
3. Fix the other end of anti-collapse chain on the wall with screw (ST4.2X38) (see fig. 4).

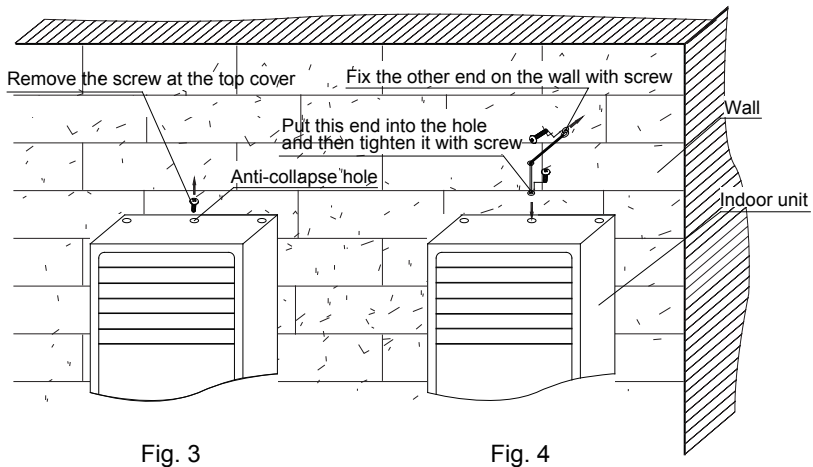

Fig. 3

Fig. 4

- The above fig may be different from the actual products; please refer to the actual products.



# Configuration of connection pipe

1. Standard length of connection pipe
  - 5m, 7.5m, 8m.
2. Min. length of connection pipe is 3m.
3. Max. length of connection pipe.

| Cooling capacity      | Max length of connection pipe |
|-----------------------|-------------------------------|
| 5000Btu/h<br>(1465W)  | 15                            |
| 7000Btu/h<br>(2051W)  | 15                            |
| 9000Btu/h<br>(2637W)  | 15                            |
| 12000Btu/h<br>(3516W) | 20                            |
| 18000Btu/h<br>(5274W) | 25                            |

| Cooling capacity       | Max length of connection pipe |
|------------------------|-------------------------------|
| 24000Btu/h<br>(7032W)  | 25                            |
| 28000Btu/h<br>(8204W)  | 30                            |
| 36000Btu/h<br>(10548W) | 30                            |
| 42000Btu/h<br>(12306W) | 30                            |
| 48000Btu/h<br>(14064W) | 30                            |

4. The additional refrigerant oil and refrigerant charging required after prolonging connection pipe
  - After the length of connection pipe is prolonged for 10m at the basis of standard length, you should add 5ml of refrigerant oil for each additional 5m of connection pipe.
  - The calculation method of additional refrigerant charging amount (on the basis of liquid pipe):
 

Additional refrigerant charging amount = prolonged length of liquid pipe × additional refrigerant charging amount per meter
  - Basing on the length of standard pipe, add refrigerant according to the requirement as shown in the table. The additional refrigerant charging amount per meter is different according to the diameter of liquid pipe. See the following sheet.

# Configuration of connection pipe

Additional refrigerant charging amount for R22, R407C, R410A and R134a

| Diameter of connection pipe |                | Outdoor unit throttle |                          |
|-----------------------------|----------------|-----------------------|--------------------------|
| Liquid pipe(mm)             | Gas pipe(mm)   | Cooling only(g/m)     | Cooling and heating(g/m) |
| Φ6                          | Φ9.52 or Φ12   | 15                    | 20                       |
| Φ6 or Φ9.52                 | Φ16 or Φ19     | 15                    | 50                       |
| Φ12                         | Φ19 or Φ22.2   | 30                    | 120                      |
| Φ16                         | Φ25.4 or Φ31.8 | 60                    | 120                      |
| Φ19                         | —              | 250                   | 250                      |
| Φ22.2                       | —              | 350                   | 350                      |

5. If the outdoor unit is higher than the indoor unit for more than 5m, an oil return bend is needed.

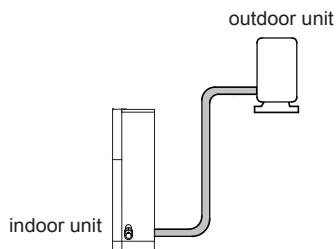

Below 5m

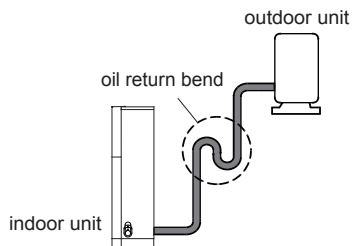

Above 5m

# Pipe expanding method

## Note:

Improper pipe expanding is the main cause of refrigerant leakage. Please expand the pipe according to the following steps:

### A: Cut the pipe

- Confirm the pipe length according to the distance of indoor unit and outdoor unit.
- Cut the required pipe with pipe cutter.

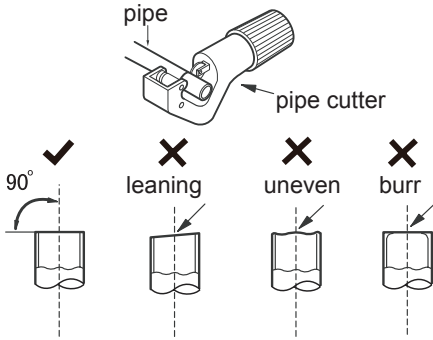

### B: Remove the burrs

- Remove the burrs with shaper and prevent the burrs from getting into the pipe.

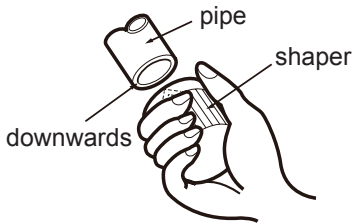

### C: Put on suitable insulating pipe

### D: Put on the union nut

- Remove the union nut on the indoor connection pipe and outdoor valve; install the union nut on the pipe.

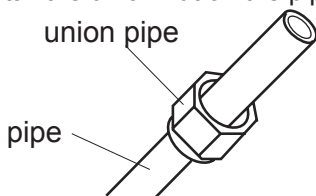

### E: Expand the port

- Expand the port with expander.

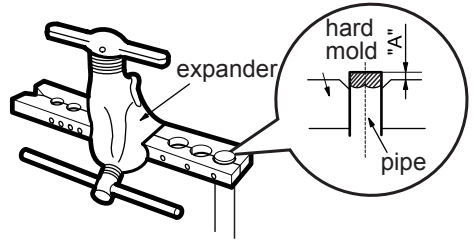

### Note:

- "A" is different according to the diameter, please refer to the sheet below:

| Outer diameter (mm) | A(mm) |     |
|---------------------|-------|-----|
|                     | Max   | Min |
| Φ6-6.35(1/4")       | 1.3   | 0.7 |
| Φ9.52(3/8")         | 1.6   | 1.0 |
| Φ12-12.7(1/2")      | 1.8   | 1.0 |
| Φ15.8-16(5/8")      | 2.4   | 2.2 |

### F: Inspection

- Check the quality of expanding port. If there is any blemish, expand the port again according to the steps above.

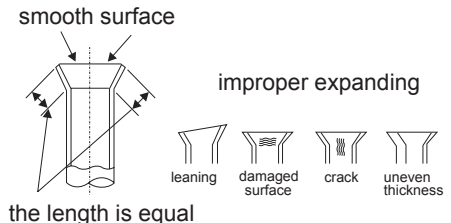



**MegaLife**

**[www.megalife.ma](http://www.megalife.ma)**

**Made BY ML ELECTRONICS**



66129931293